



PF 20



TECHNICAL DATA

Fluid connections	3/4" tri-clamp BS 4825
Air connection	1/4" BSPP
Max. flow rate	20 lt/min
Max air pressure	7 bar
Max delivery head	70 m
Max suction lift dry	5 m
Max suction lift wet	9,8 m
Max solid passing	2,5 mm
Noise level	65 dB
Max viscosity	10.000 cps

Displacement per stroke **30 CC ~**

Displacement per stroke may vary based on suction condition, discharge head, air pressure and fluid type.

II 3/3 G Ex h IIC T4 Gc

II 3 D Ex h IIIB T135°C Dc X

**SS AISI 316
ELECTRO-POLISHED**

WEIGHT
2.3 kg

TEMPERATURE
-20°C +95°C



PERFORMANCE

The curves and performance values refer to pumps with submerged suction and free delivery outlet, with water at 20 °C. These data may vary according to the construction materials and hydraulic conditions.

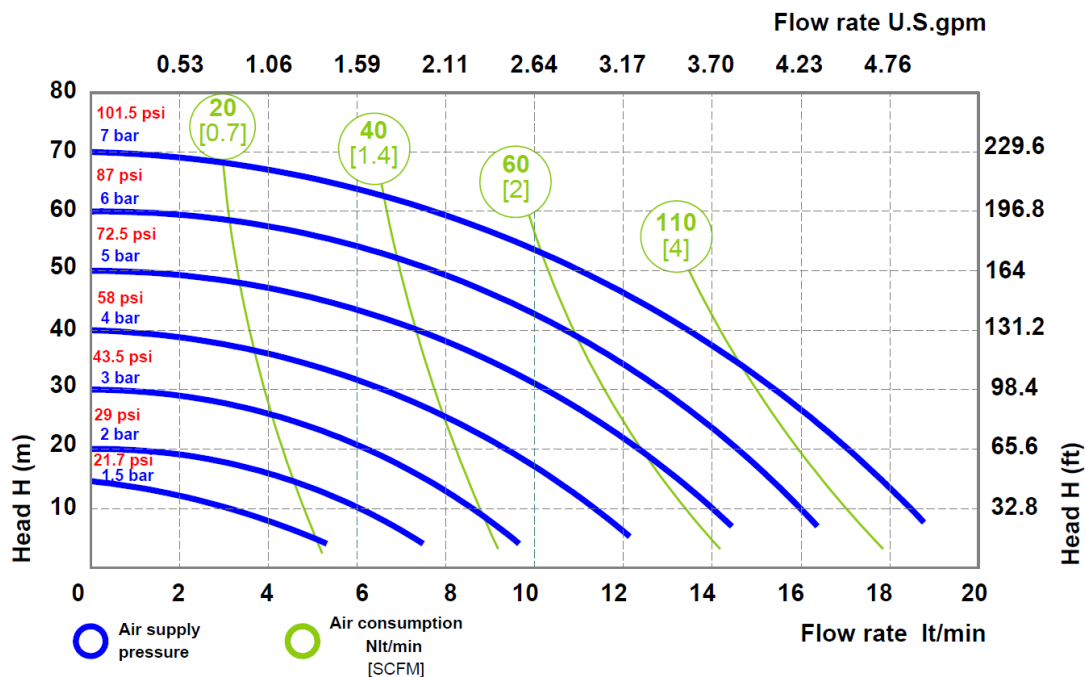

FLUIMAC S.r.l. - Via Breascia, 1 - 21049 - Tradate - VA - ITALY
info@fluimac.com - www.fluimac.com
 tel. +39 0331 866688 - Fax +39 0331 864870
 P.I./VAT 03259160129



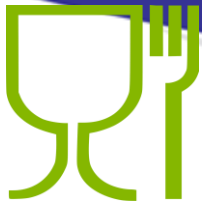

PF 20

COMPOSITION

MODEL	CASING	DIAPHRAGM	BALLS	SEATS	GASKET	CONNECTIONS	ATEX	PORTS
PF0020	SS = SS ELECTR O- POLISHE D	HT = HYTREL+PTFE	T=PTFE S=SS	S=SS	T = PTFE	1 = BSPP 3 = TRI-CLAMP 6 = DIN	- = ZONE 2	AB = STANDAR D

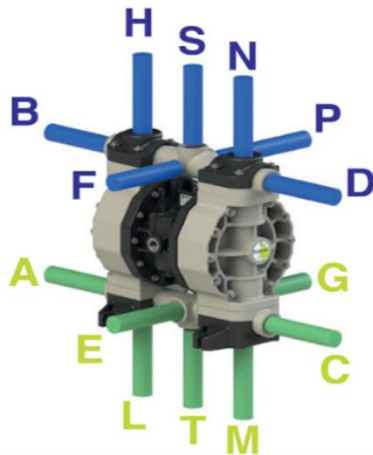

AVAILABLE CONNECTIONS

DELIVERY: B-D-S

SUCTION: A-C-T

PACKING DIMENSION

CARTON BOX: 24 x 21 x 12 cm

DIMENSIONS

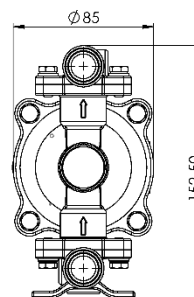
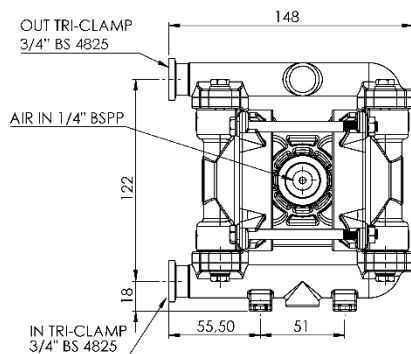
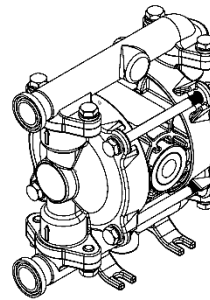
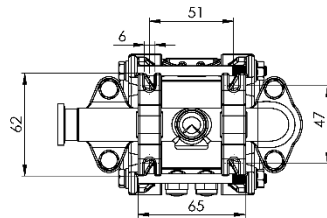

Technical data are approximate and not binding for the manufacturer who reserves the right to change them without notice at any time.

Made in Italy

fluimac
pump solution

FLUIMAC S.r.l. - Via Breascia, 1 - 21049 - Tradate - VA - ITALY
info@fluimac.com - www.fluimac.com
tel. +39 0331 866688 - Fax +39 0331 864870
P.I./VAT 03259160129

ISO 9001
BUREAU VERITAS
Certification
1835
ISO 9001:2008